

USER MANUAL

For LCC system products

(Indoor monitor with built-in power supply)

Luxurious in appearance

Unparalleled in technology

2018-V01

CE FC RoHS 

LCC SYSTEM CONFIGURATION DIAGRAM

► For two doors

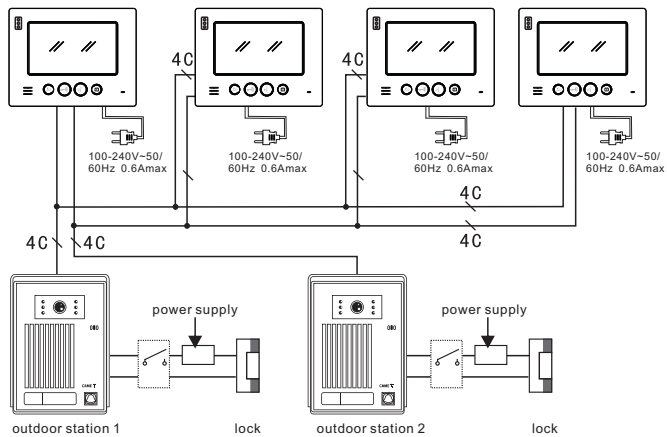

Notice:

- 1、LCC wire:
 - a Untwisted cable
 - b Wire diameter $\geq 0.2\text{mm}^2$, from the outdoor station to the farthest indoor monitor $\leq 28\text{m}$;
Wire diameter $\geq 0.3\text{mm}^2$, from the outdoor station to the farthest indoor monitor $\leq 50\text{m}$;
Wire diameter $\geq 0.5\text{mm}^2$, from the outdoor station to the farthest indoor monitor $\leq 70\text{m}$.
- 2、Maximum 4 indoor monitors and 2 outdoor stations can be connected in parallel.
- 3、Functions of transfer call and internal call are not applicable in indoor monitor with two buttons handset and three buttons handsfree types.
- 4、Each indoor monitor required power supply: 100-240V~50/60Hz 0.6Amax

Installation information for indoor monitor

Installation diagram

1. Locate the bracket on the installation place, keep it horizontal and mark the drilling positions;
2. Drill holes according to the marked drilling positions and pad with screw anchors;
3. Fasten the bracket with the screws properly on the installation place;
4. Connect the indoor monitor according to the wiring diagram;
5. Mount the indoor monitor properly on the bracket hooks.

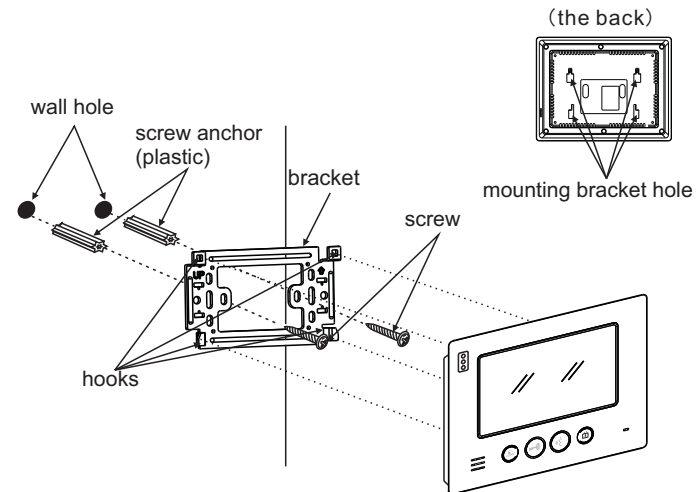

Installation information for outdoor monitor

built-in

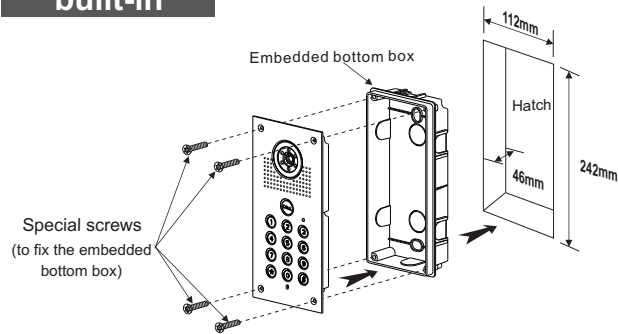

wall-hanging

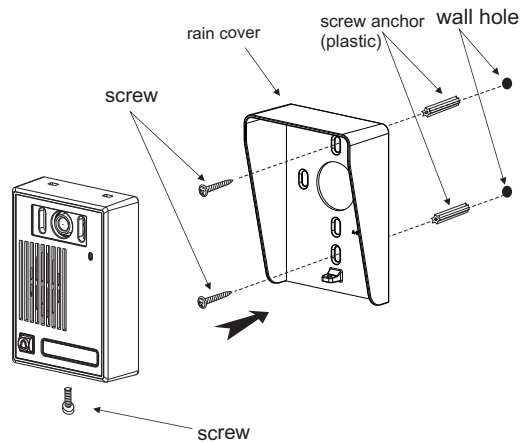

Button diagram for indoor monitor

NO.	Icon	Description	NO.	Icon	Description
①		Monitor	⑥		Ringing volume
②		Calling	⑦		Menu
③		Door lock releasing	⑧		Exit
④		Talking	⑨		Select
⑤		Talking volume	⑩		Select

Technical parameters for indoor monitor

Power	100-240V~50/60Hz 0.6Amax
Communication duration	120s
Communication method	Duplex communication
Working temperature	-20°C~+55°C

Technical parameters for outdoor station

Voltage: DC +12 ~ +15V	Working temperature: -20°C~+55°C
Standby current: 10mA	Working current: 100mA
Mode: Dual transmission	Conversation time: 2 minutes

Wiring diagram

► Wiring method

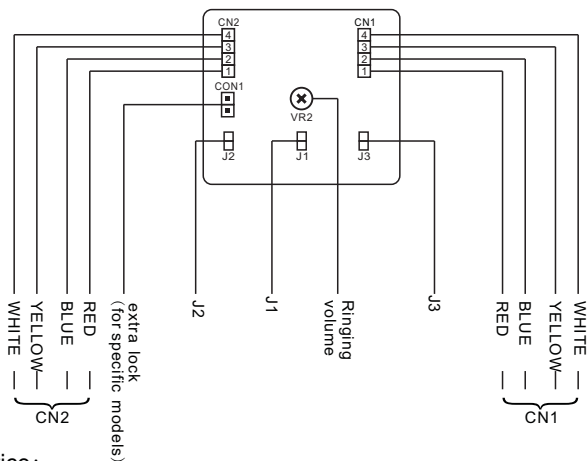



Notice:





1. When the outdoor station (one household) connects more than one indoor monitor, please connect J2 of the farthest indoor monitor from the outdoor station and pull out all the J2 of the rest of indoor monitors.
2. When the outdoor station (one household) connects more than one indoor monitor, please connect J1 and J3 of the nearest indoor monitor from the outdoor station and pull out all the J1 and J3 of the rest of indoor monitors.
3. When the outdoor station connects over two households (including two houses), please pull off J3 of all the indoor monitors.

Operation method



► Visitor calls

Visitor presses the call button of outdoor station and indoor monitors ring and display the camera picture. Press  on the indoor monitor to talk with the visitor. Maximum talking time is 2 minutes. Press  again to end the call.



► Monitor video and audio

Press  on the indoor monitor to monitor the CN1 outdoor station with the indicator light of this outdoor station on. Press  again to monitor the CN2 outdoor station with the indicator light of this outdoor station on. Press  third time to end the monitor. Press  to monitor the audio.

► Call transfer (except some models)

During the talk between outdoor station and indoor monitor, press  to ring all the rest of the indoor monitors. Any indoor monitor can pick up the call and talk to the outdoor station. Press  to manually exit the talk, or the system will cut off the talk in 2 minutes.

► Internal call (except some models)

In standby mode, press  on any indoor monitor, all the indoor monitors ring. Press , indoor monitor can talk to another indoor monitor. Internal call function supports call transfer function.





► Unlock

Press  to unlock the door ,the system will not cut off after unlocking, indoor monitor can unlock the door that is monitoring.

► For extra lock

Press  button of the indoor monitor to unlock extra lock.
(for specific models)

► Select ringtone

In standby mode, press  and  button in the same time.
 button is for selecting different ringtones, and  button is for confirming the selection. Each ringtone lasts for 5 seconds. (for specific models)

Picture memory function

For the model with 100 pictures stored

Auto capture



When the outdoor station calls the indoor monitor, one picture will be captured in the 1st second. It only captures one picture automatically (Do not support automatic continuity capture).



NOTICE

Maximum storage: 100 pictures. After the number reaches 100, the oldest picture will be deleted automatically as long as a new picture is captured.

Check picture

In standby mode, choose   for pictures checking. Without any move in 10 seconds will return to standby mode.

Menu interface

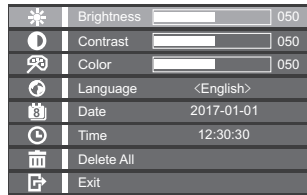

Delete picture



Choose DELETE ALL to delete all the pictures in the memory. Delete single picture: when checking the picture, press , then pop up delete information. Press  to confirm the deletion.

Brightness adjustment



Press   to adjust. (Brightness value is 0-100)

Contrast adjustment



Press   to adjust. (Contrast value is 0-100)



Color adjustment



Press   to adjust. (Color value is 0-100)

Language setting



Choose language.   to choose different languages for operation use.



Notice: there are two types of language groups.

Language group A: Chinese, English, Polish, Russian, French, Italian, German, Spanish

Language group B: Chinese, English, Greek, Turkish, Portuguese, Hebrew, Japanese, Korean

Date setting





Choose DATE (display order: YYYY - MM - DD). Press   to select figure. Press  to change from YEAR-MONTH-DATE.

Time setting



Choose TIME (display order: HOUR - MINUTE - SECOND).

Press   to select figure. Press  to change from HOUR - MINUTE - SECOND.

Exit setting



Press MENU button to exit the setting mode. Or press return to main menu to exit. Without any operation, the system will return to menu automatically in 10 seconds.

==== Password function operation ====

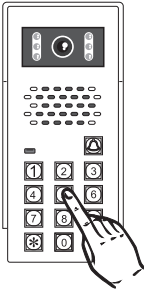

NOTICE:

- 1、 Factory default programming password is 1234.
- 2、 In the programming mode, 40 sets of 4 digits password can be set to unlock door.

----- Set new programming password -----

Switch off the power first, press and hold *, switch on the power in the same time. After hearing one long notification tone, release *. Then hear another notification tone, and enter new 4 digits programming password. DI DI DI DI DI indicate the new password is entered.

----- Enter to the programming mode -----

Press * and hear two notification tone DI, then enter 4 digits programming password. Hear DI DI DI DI and LED light blinking indicate it is in the programming mode. Press * to exit the programming mode and hear DI DI DI DI DI.

----- Set unlock time -----

Enter to the programming mode first. Press 0 0 and hear 2 notification tones DI. Enter figure (from 01 - 99 seconds) for unlock time. Hear DI DI DI DI and return to programming mode. Press * to exit the programming mode

----- Add unlock password by different places -----

In the programming mode, enter figure (from 01 - 40) for adding place. Hear DI DI indicates success. Enter 4 digits unlock password. Hear 2 long notification tone DI indicates adding password failed, please change another 4 digits password. Hear DI DI DI indicates adding successfully. Return to programming mode.

----- Delete unlock password by different places -----

In the programming mode, enter figure (from 01 - 40) for deletion place. Hear DI DI indicates success. Press # to delete the password in this place. Hear DI DI DI DI and return to programming mode.

----- Delete unlock password directly -----

In the programming mode, press # and hear DI DI. Enter 4 digit unlock password. Hear DI DI DI DI indicates this password is deleted. Return to programming mode.

----- Delete all settings -----

In the programming mode, press #, and hear DI DI. Then press # and hear DI DI. After that, press # for 7 times. The system will delete all settings. Unlock time becomes 1 second. Programming password will not change. DI DI DI DI DI indicate the system reset and delete all unlock password.

Access control DH11/12R

DH11R and DH12R are access controls. They are used in the outdoor stations with with ID/IC card and fingerprint. They have wireless sensor for adding and deleting cards and fingerprint. The main parts are wireless sensor keypad DH11R/DH12R.

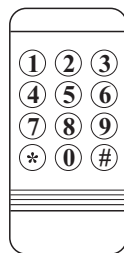

DH11R

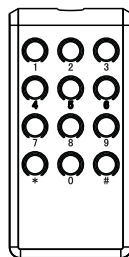

DH12R

DH11R sensor keypad technical parameters

Silver zinc button batteries(2032): 3V	
Working current: $\leq 0.5\text{mA}$	Sensor distance: all around: $\leq 20\text{cm}$
Enter corresponded number to replace the relative ID/IC card	

DH12R sensor keypad technical parameters

Use two No.7 LR03 AAA 1.5V alkaline batteries	
Working current: $\leq 0.5\text{mA}$	Sensor distance: all around: $\leq 20\text{cm}$
Enter corresponded number to replace the relative ID/IC card	

ID card reader operation guide

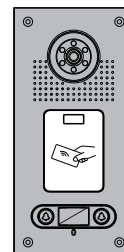

Notice:

DH11R or DH12R is required for operation.

Enter to the setting mode

Press - * - # system password - #. Hear DI indicates entering the setting mode (Exit the setting mode without any operation in 20 seconds).

Note: Factory default system password is 4567.

Change system password

Enter setting mode first. press 8 and hear one notification tone DI. Enter new 4 digits password and #. After 2 notification tone DI, enter the new 4 digits password again and #. Hear DI indicates the modification is successful. Hear continuous DI- indicates two passwords are not the same. Please change the system again.

Note: If forgot system password, cut off the power and put on again. Press and hold # within 3 seconds. Hear notification tone BI indicates the system password is reset to 4567.

Set master card

In the setting mode:

Press 0, and hear notification tone DI. Press 7, and hear DI. Enter the last 6 digits master card number or swipe the master card. Hear DI indicates master card is set successfully. Press * to return to setting mode. Press * twice to standby mode.

----- Add ID card -----

In the setting mode, press 1 and hear DI indicates it is in adding card mode. Enter last 6 digits card number of the new ID card. Hear DI indicates adding successfully. Or swipe the card and hear DI DI indicates adding successfully. Continuous adding batch new cards: Swipe cards one by one and ignore DI DI tones. Four tones DIDIDIDI indicate this card is added before. Press * to return to setting mode. Press * again to standby mode. No operation in 30 seconds will return automatically.

Add new card by using master card:

In standby mode, swipe master card and hear DI indicates it is in the adding card mode. Swipe one new card will hear DI DI which indicates adding successfully. DIDIDIDI indicate this card is added before. Swipe the master card again to return to standby mode.

----- Delete ID card -----

In the setting mode, press 2 and hear DI indicates it is in the deleting card mode. Enter last 6 digits card number of the ID card. Hear DI indicates deleting successfully. Or swipe the card and hear DI DI indicates deleting successfully. Continuous deleting batch cards: Swipe card one by one and ignore DI DI tones. DIDIDIDI indicate this card is deleted before.

----- Delete all cards -----

In the setting mode, press 9 and hear DI. Then press 9 and hear continuous DI---tones. Notification tone stops indicates deleting all the cards successfully.

----- Set unlock time -----

In the setting mode, press 4 and hear DI. Then enter 2 digits (01 - 99 seconds) for unlock time.

===== Finger print function operation =====

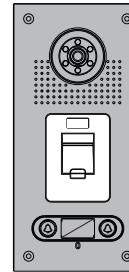

Note:

DH11R or DH12R is required for operation.

-----Enter to setting mode-----

Enter system password twice (1234 - 1234), yellow indicator light is on indicates it is in the setting mode.

Note: Factory default system password is 1234.

-----Change system password-----

In the setting mode, press * 3 (yellow light blinking). Enter 4 digits new password twice. Hear one notification tone BI means system password is changed successfully.

Note: If forgot system password, cut off the power and put on again. Press and hold # within 3 seconds. Hear notification tone BI indicates the system password is reset to 1234.

----- Change unlock time -----

In setting mode, press * 1 (yellow light blinking). Enter any digit from 01 to 99. Notification tone BI heard and yellow light on indicate setting is successful. Note: 01-99 indicate 1 to 99 seconds.

----- Add finger print -----

In setting mode, enter any digit from 000-899, red light on indicates this place stores finger print. Press * twice to delete the finger print. Green light on and add finger print again. Press one finger on the reader and 3 discontinuous notification tone BI indicates the finger print is stored successfully. 3 continuous notification tone BI indicates the finger print is not stored successfully. 4 continuous notification tone BI indicates the finger print is stored in the system.

Note: Maximum 900 finger prints stored

----- Delete finger print -----

In setting mode, enter place digit and press * twice to delete the finger print stored. Delete all finger prints: Press *--8 (yellow light blinking). Enter 8 twice. Long BI- tone indicates deleting. Notification tone stops means deleting successfully.

----- Reset factory default -----

In setting mode, press *--8 (yellow light blinking). Enter 9 twice. Notification tone BI heard indicates reset to factory default.

----- Set security level -----

In setting mode, press *--5 (yellow light blinking). Enter digit twice from 1 to 5 (5 indicates the fingerprint recognition accuracy is the highest). Notification tone BI indicates setting is successful. Notification tone BI BI BI indicates setting is not successful.